



stream plus

latest developments



In addition to the CMS Concerto and Stream/accessories brochures CMS ergo are pleased to present the following developments:

Stream Plus

Our Stream plus range has been reengineered to meet the proportional balance between the cost of monitors and monitor arms.

Configurations include single screen through to 4 screen applications.

A cost effective solution; whilst still being aesthetically pleasing to the eye.

The Stream Plus range has many workstation possibilities, but if your desired requirement is not shown or you require further advice on your appropriate configurations then please contact us.



Stream Plus tool rail and accessories

Designed to be used as a space saving, cost effective solution for existing and new workstations; A full range of accessories including document holders and stationary trays are also available.



Ergonomic Laptop Stand

Awarded the 'iF Product design award 2008' for design excellence, this product in simplicity is an ergonomic support for laptop computers. Solving the problem of user's inappropriate posture with 6 options of visual height adjustment, It positions the screen to provide a more comfortable working environment.

Latest Product developments – Butterfly

This is our first monitor arm to offer inbuilt cable management and incorporate a patented 'rise and fall' height adjustment system.



T 01235 773373
E sales@cmsergonomics.com

modular flexibility
with contemporary styling

the stream plus range



Clamp fixing dual beam arm CMS1636/CMS1634







the stream plus range

This range has been reengineered to offer a cost effective yet aesthetically pleasing solution to ergonomic requirements, redeveloped to address the significant financial imbalance between cost of monitor and cost of monitor arm.

Produced using 98% of a single material, also a key factor in the redevelopment, in order to assist and encourage the end user to recycle and enable the ease of disassembly.



Key Design Features

-  Value Engineered, cost effective solution to ergonomic requirement
-  Full Range of movement including height adjustment, tilt, rotation and reach
-  Comes ready assembled for quick and easy installation
-  A variety of fixing options available including tool rail bracket, clamp post and through desk
-  98% of a single material is used in manufacturing. Easy disassembly aides recycling
-  caters from 1-4 Screen applications
-  Locking system available

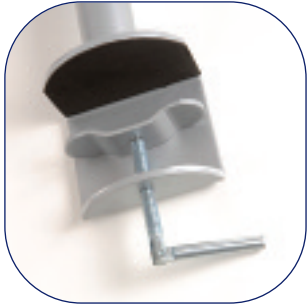

Clamp post CMS1634

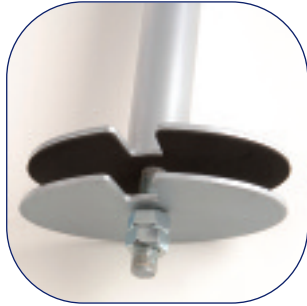

Through desk fixing post CMS1635



Single beam tool rail CMS1712

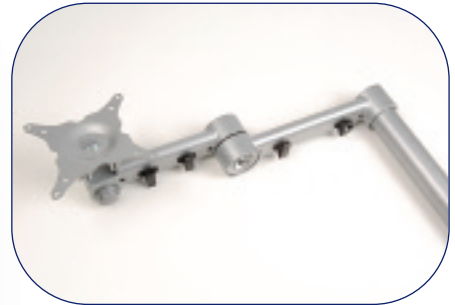

Dual beam tool rail CMS1713

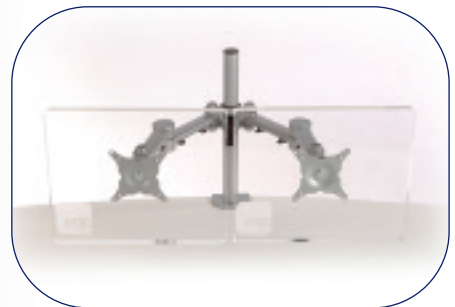

CMS1787 two screen arm with
CMS1634 Clamp post

portable laptop stand



Portable laptop stand

This award winning laptop stand is not only stylish but lightweight and portable, and comes with a durable Neoprene carry case that doubles as a mouse mat.

The unique design has a hollowed out rear to disperse heat to stop laptops overheating and is compatible with most laptops and Macs.







Creates the perfect ergonomic support for laptops; solving the problem of user's inappropriate posture with six options of visual height.

Ideal for restricted space use such as in flight use of laptop / train travel.





Key Design Features

-  Award winning design
-  Folds away and portable for use on the go, comes complete with neoprene carry case
-  Compatible with most laptops and notebooks
-  6 angles of height adjustment
-  Light weight – 550g
-  All materials used in production are 100% recyclable



stream plus tool rail

The Stream Plus tool rail system has been designed to be used as a space saving cost effective solution for existing and new workstations. Where ergonomics and desk space are required the system can be used from both sides and all CMS Ergo tool rail arms are compatible.

Accompanying the tool rail we offer a full range of accessories including Perspex screens, document holders and stationary trays.

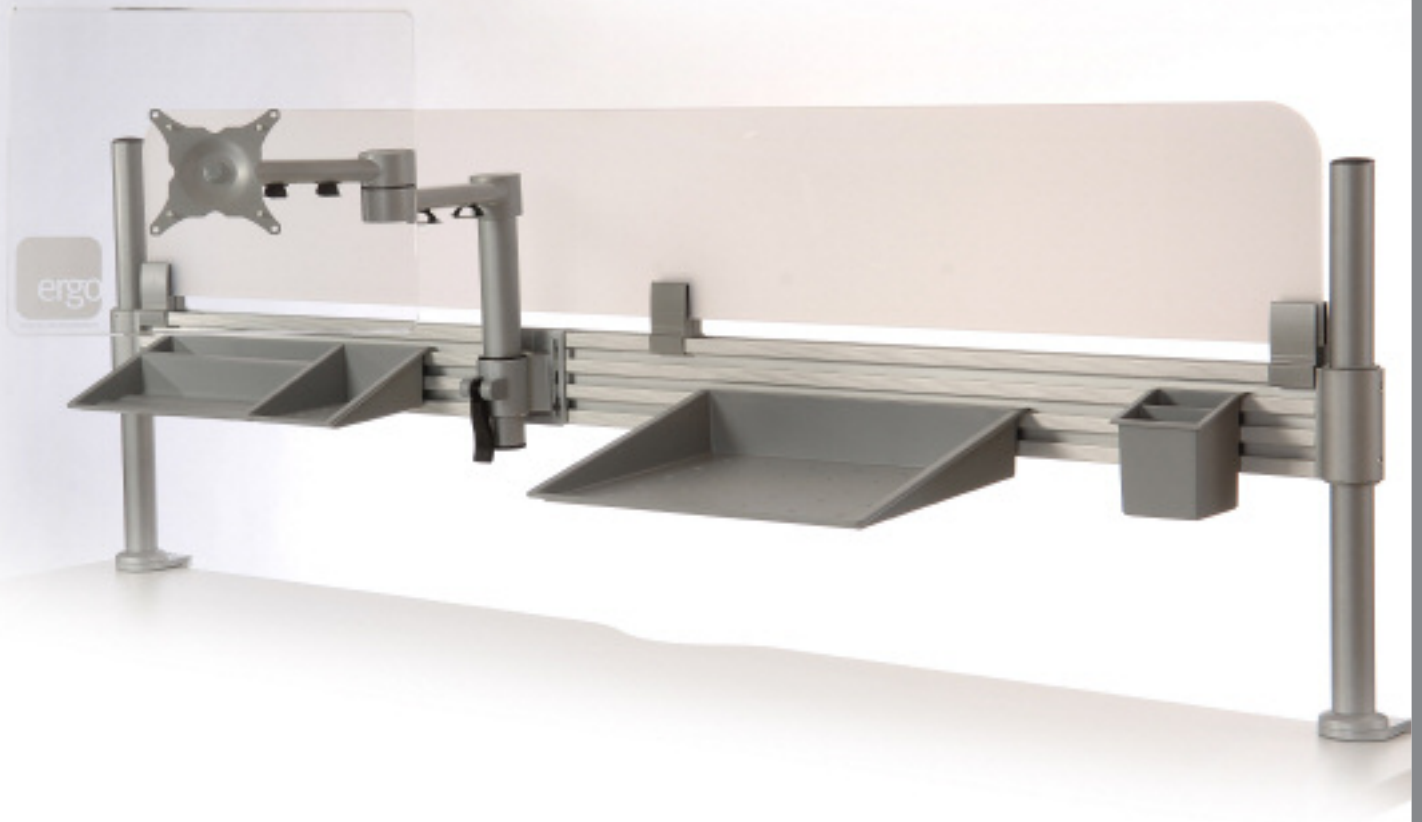

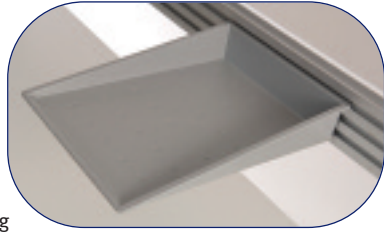

A4 tray long

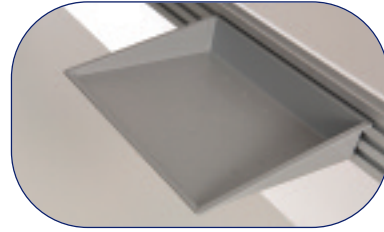

A4 tray wide

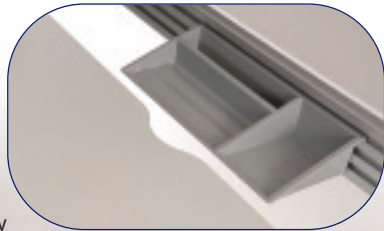



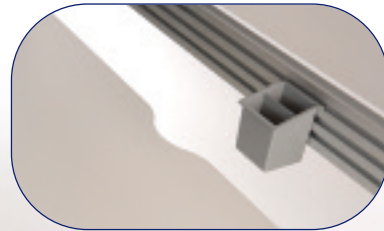



Stationery tray



Pencil/Pen holder









Key Design Features:

-  Engineered for use with existing and new workstations
-  Multiple applications / configurations available
-  Cost effective storage/workstation solution
-  Clamp fixing as standard – other features available on request
-  Tool rail is height adjustable
-  Quick fixings to existing workstations

CMS Ergo Butterfly Arm

CMS ergo have developed the stylish new butterfly arm. The patented 'rise and fall' system offers a value alternative to existing gas systems. Offering the user simple height adjustment via a ratchet, this arm also has a concealed cable management feature. The first in our range to do so.

Key Design Features

-  New 'rise and fall' height adjustment design
-  Quick release monitor mounting, unique post cable management
-  Front end height adjustment
-  Fixings include Clamp, through desk and tool rail
-  1-4 screen applications
-  Lockable system available

In House Cad Development.

CMS Ergo are pleased to also offer customers In House Cad development. Using the software Solidworks – the first validation software created to enable engineers and designers to improve on product quality and safety by testing 3D CAD models under real world conditions prior to manufacture. Thus giving our development team mechanical design verification, data management and communication tools all within the same package.

Our skill set and knowledge can give full or part project management to your ideas and designs.

Please contact us to discuss how we can assist you further.

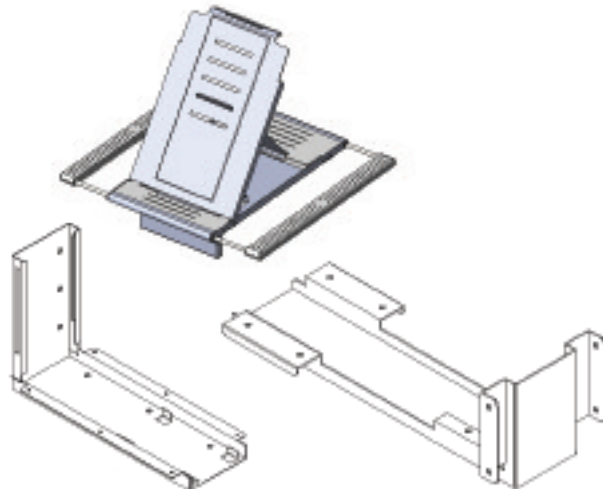



CMS Ergo

Operating from our headquarters in Wantage, Oxfordshire; CMS Ergo have modern purpose built offices and warehouse facilities totalling 24,000ft²



Stock Holding

Our offices and warehouse facility enables us to accommodate increased stockholdings to satisfy the 'just in time' deliveries. With facilities to hold in excess of 3,400 pallets.



Showroom

All of our products are on display in our showrooms, please contact our sales team if you would like to arrange a visit.



Logistics

With a strong delivery network we are able to deliver to anywhere in the UK & Europe.



Environment

CMS Ergo take our Corporate Social Responsibility and companies impact on the environment very seriously.

In new product development we focus on material composition striving to achieve full recyclability.

A registered member of Paperpak we comply with the producer responsibility obligation regulations 2007.

CMS Ergonomics

Downsview House
Grove Technology Park
Wantage
OXON OX12 9FF

T: 01235 773373

F: 01235 773371

W: www.cmsergonomics.com

E: sales@cmsergonomics.com



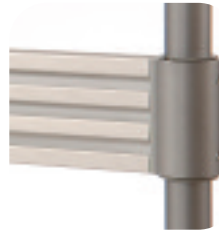

CMS Ergonomics
Downsview House
Grove Technology Park
Wantage
OXON OX12 9FF

T: 01235 773373
F: 01235 773371
W: www.cmsergonomics.com
E: sales@cmsergonomics.com

